

	User & Installation manual VHF- Communication Transceiver	Doc.-Nr: DE-3000-800100e
	KRT2 & KRT 2A	Revision 9.6 For Software >5.00 Sept.2013

KRT2

VHF Communication Transceiver



P/N 100-(0001)-(060)

Operation and Installation Manual

	User & Installation manual VHF- Communication Transceiver	Doc.-Nr: DE-3000-800100e
	KRT2 & KRT 2A	Revision 9.6 For Software >5.00 Sept.2013

	User & Installation manual VHF- Communication Transceiver	Doc.-Nr: DE-3000-800100e
	KRT2 & KRT 2A	Revision 9.6 For Software >5.00 Sept.2013

Record of Revisions

Revision	Date	Subject
1	06 Juni 2010	First issue
2	20 Sep 2010	Revision Stecker / Redaktionelle Änderungen
3	05 Feb 2011	Editorial update
4	04 Mai 2012	Cable-harness correction
5	16 Mai 2012	Software advantage for battery indication, error reports
6	19.Aug 2012	Hints for mic. Installation & intercom
7	Sept. 2012	Correction wiring
8	Dec. 2012	Dynamic Microphone GND-wiring
8.1, 8,2	Feb.2013	Text corrections
9	March 2013	Additional drawing, clarify microphone GND
9.1	March 2013	Text corrections
9.2	April 2013	Hints in drawings
9.3		
9.4		
9.5		Simplification of memory handling

List of Service-Bulletins (SB)

Service-Bulletins have to be inserted in the manual, and entered in the table.

SB Number	Rev. No.	Date Issued	Date Inserted	Name

Unit overview

Item No.	Product Overview
	Basic Version

	User & Installation manual VHF- Communication Transceiver	Doc.-Nr: DE-3000-800100e
	KRT2 & KRT 2A	Revision 9.6 For Software >5.00 Sept.2013

	Introduction of:: <ul style="list-style-type: none"> • 2 Standard Microphone Inputs • Auxiliary Audio Input • DUAL Watch Function
--	--

	User & Installation manual VHF- Communication Transceiver	Doc.-Nr: DE-3000-800100e
	KRT2 & KRT 2A	Revision 9.6 For Software >5.00 Sept.2013

TABLE OF CONTENTS

1	GENERAL	6
1.1	Symbols	6
1.2	Abbreviations.....	7
1.3	Customer Service.....	8
1.4	KRT2 Transceiver properties	8
2	Installation limitation	9
3	CONTROL general.....	9
3.1	Control Elements Overview	9
3.2	Display.....	11
4	OPERATION	13
4.1	General.....	13
4.2	ON / OFF Switching.....	13
4.3	Frequency Selection	13
4.3.1	Direct Frequency Selection	14
4.3.2	Frequency Selection from the Favourites List	14
4.3.3	Storing and Editing Favourites.....	15
4.4	AUD – Audio Menu	18
4.4.1	VOL – Volume	18
4.4.2	SQ -- Squelch	18
4.4.3	VOX – Intercom Voice Trigger Level Setting	19
4.4.4	Manual Intercom.....	19
4.4.5	TXm – PTT Switch Selection	20
4.4.6	INT – Intercom Volume	20
4.4.7	EXT – External Audio Input Volume	20
4.4.8	DIM – Display Brightness (Batt.-voltage)	20
4.4.9	CON – Display Contrast.....	20
4.4.10	SIT – Side tone	21
4.4.11	MIC – Setup	21
4.4.12	Menu locking.....	23
4.5	DUAL Watch.....	24
4.6	Transmitter Operation.....	25
4.7	Self test monitor.....	27
4.7.1	Optical side tone.....	27
4.8	Resetting to factory settings	28
4.9	SET UP - Menu	29
4.9.1	ERASE – Erasing the Favourites List	29
4.9.2	Channel Spacing.....	30
5	Remote Control	30
6	Installation	32
6.1	Installation Hints.....	32
6.2	Telecommunication Data.....	32
6.3	Scope of delivery	32
6.4	Unpacking and Inspecting the Equipment.....	33

	User & Installation manual VHF- Communication Transceiver	Doc.-Nr: DE-3000-800100e
	KRT2 & KRT 2A	Revision 9.6 For Software >5.00 Sept.2013



6.5	Mounting	33
6.6	Electrical Connections	34
6.6.1	Microphone-Connection.....	34
6.6.2	Earphone Connection	35
6.6.3	External Audio Input.....	35
6.7	Finally Audio-Setup	36
6.7.1	For gliders	36
6.7.2	For motor gliders.....	36
6.7.3	Für Motor planes	36
6.8	Wiring.....	37
6.8.1	Wire Gauges	37
6.8.2	Connector Pin-Configuration	37
6.8.3	Wiring Diagram.....	38
6.8.3.1	Full connection.....	38
6.8.3.2	Glider single.....	40
6.8.3.3	Motor glider single.....	41
6.8.3.4	Glider dual	42
6.8.4	Wiring for dynamic microphones	43
6.8.5	Connection support	43
6.9	Antenna.....	44
6.9.1	Antenna Selection	44
6.9.2	Installation Recommendation.....	44
6.10	Microphone general	45
6.11	Post-Installation Check	45
6.12	Starting Up	46
6.13	Accessories	47
6.14	Drawings	47
6.14.1	Dimensions.....	47
6.14.2	Installation Directions	48
7	Maintenance.....	49
7.1	Periodic Maintenance	49
7.2	Repair.....	49
7.3	Cleaning.....	49
8	ANNEX.....	50
8.1	Frequency / Channel- schedule.....	50
8.2	Technical Data.....	51

	User & Installation manual VHF- Communication Transceiver	Doc.-Nr: DE-3000-800100e
	KRT2 & KRT 2A	Revision 9.6 For Software >5.00 Sept.2013

1 GENERAL

This manual contains information about the physical, mechanical and electrical properties as well as a description for the operation and installation of the VHF airborne transceiver KRT2.

1.1 Symbols

	WARNING Non compliance may cause personnel injury due to radiation or fire.
	CAUTION Non-compliance may cause damage or incorrect operation of the transceiver.
	INFORMATION

	User & Installation manual VHF- Communication Transceiver	Doc.-Nr: DE-3000-800100e
	KRT2 & KRT 2A	Revision 9.6 For Software >5.00 Sept.2013

1.2 Abbreviations

Abb	Description	Definition
PTT	Push to Talk	Transmitter activation
VOX	Voice operated intercom	Voice level setting for the activation of the intercom
INT	Intercom level	Intercom volume level setting
SQ	Squelch	Squelch setting
DIM	Dimming	Display brightness setting
CON	Contrast	Display contrast setting
EXT	External audio input	External Audio input level setting

	User & Installation manual VHF- Communication Transceiver	Doc.-Nr: DE-3000-800100e
	KRT2 & KRT 2A	Revision 9.6 For Software >5.00 Sept.2013

1.3 Customer Service

In order to process returned units most expeditiously, please fill in the form Reshipment to be found under AIRplus Service at www.airplus24.com.

	Suggestions which will improve this manual are very much appreciated at: www.airplus24.com
---	---

	Information concerning software updates are available under AIRplus Avionics at www.airplus24.com
--	--

1.4 KRT2 Transceiver properties

- VHF airborne transceiver
- Frequency range 118,000 to 136,975 MHz
- Channel spacing 8,33/25 kHz (2278 channel)
- Fast channel selection
- 4 separate microphone inputs (2 x standard or 2 x dynamics)
- Audio-input for other audio devices
- Installation: Standard panel cut-out (57 mm)
- 100 user definable frequencies with up to 8 character designators

	Continuous transmissions will be turned off after 2 minutes. (Stuck mic function).
---	--





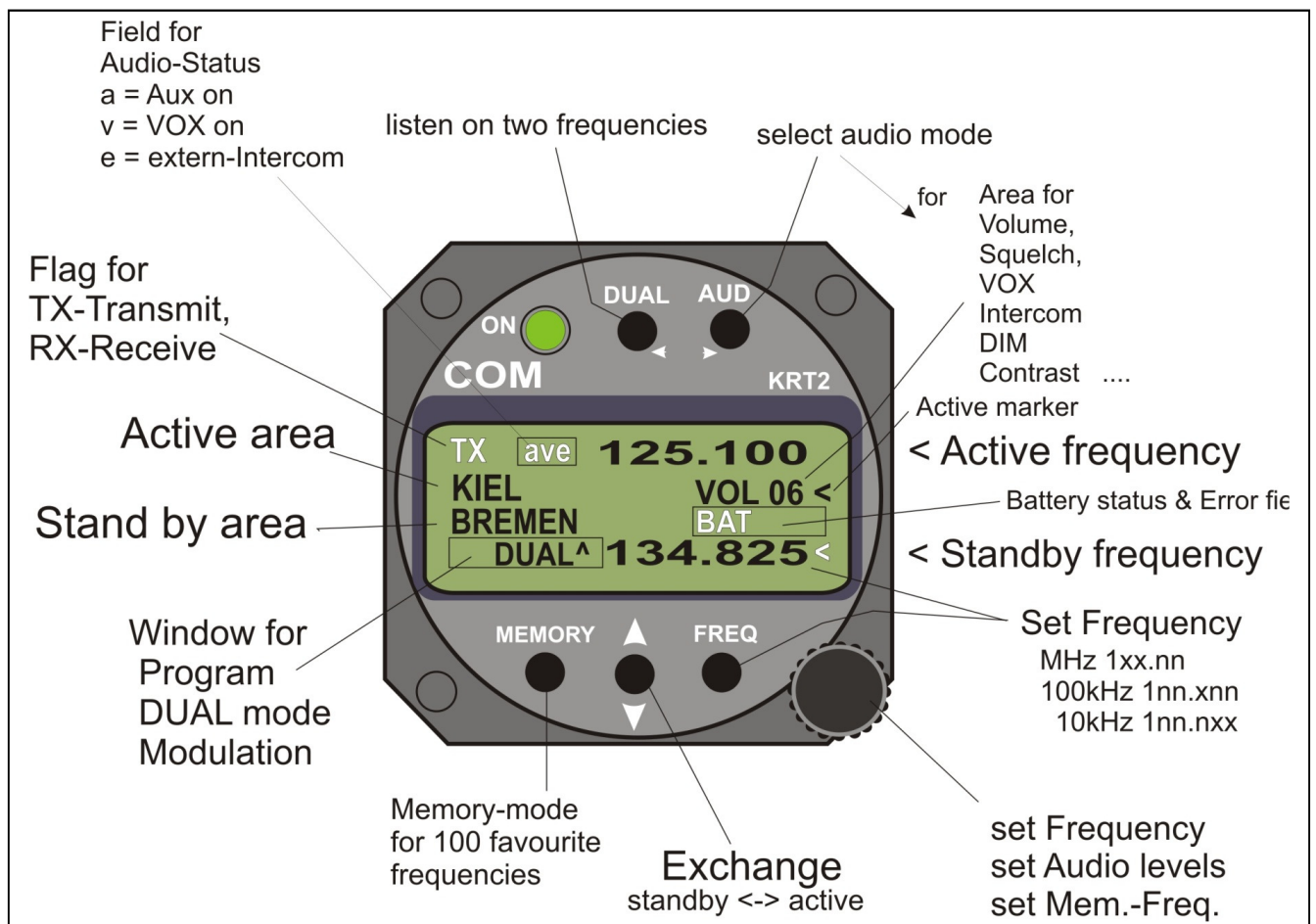

2 Installation limitation

The conditions and tests required for (E)TSO approval of this article are minimum performance standards. It is the responsibility of those installing this article either on or within a specific type or class of aircraft to determine that the aircraft installation conditions are within the (E)TSO standards. (E)TSO articles must have separate approval for installation in aircraft. The article may be installed only if the installation is performed in accordance with Part 43 or the applicable airworthiness requirements.

3 CONTROL general

3.1 Control Elements Overview



	ON / OFF	Self-locking switch
	DUAL WATCH	<ol style="list-style-type: none"> 1. Scanning between the Active and Standby frequencies 2. Positioning cursor to the left when programming the station designator
	AUDIO SELECT	<ol style="list-style-type: none"> 1. Stepping through the audio menus VOL SQ VOX TX INT EXT DIM CON SIT and MIC 2. Positioning cursor to the right when programming the station designator
	FAVOURITES	<ol style="list-style-type: none"> 1. Frequency and designator selection from the favourites list 2. Programming of favourites (frequency and designator)
	EXCHANGE	Exchange of the Active and Standby frequencies
	FREQUENCY	<ol style="list-style-type: none"> 1. Selection of the frequency range MHz, 100kHz, 10kHz 2. Toggles between frequency and designator when programming the favourites
	TURNING KNOB	<p>Sets all variable values in any menu</p> <ol style="list-style-type: none"> 1. Volume setting of headsets and speakers 2. MHz/kHz selection of the standby frequency in 3 different ranges 3. Favourite selection 4. Alpha character selection when programming favourites 5. Change of microphone settings

	User & Installation manual VHF- Communication Transceiver	Doc.-Nr: DE-3000-800100e
	KRT2 & KRT 2A	Revision 9.6 For Software >5.00 Sept.2013

3.2 Display

Indication	Meaning	Remarks
RX	Reception	RX is displayed during reception with a squelch value of 02 or more
TX	Transmission	Transmitter operates normally
Te	Transmitter was turned off automatically after 2 min continuous operation	
125.100	Active frequency	
KIEL	Active frequency station designator	Displayed when frequency and designator is stored in the favourite list
VOL	Receiver volume level (default after a certain time delay)	When AUD was pressed the corresponding Audio Menu item and setting is displayed
SQ	Squelch	
VOX	Voice operated intercom	
DIM	Display brightness	
CON	Display contrast	
INT	Intercom - Volume	
EXT	Volume of external devices	
TX**	PTT button selection	Left/Right/Both
SIDE	Side tone	During transmitter operation
BREMEN	Standby frequency station designator	Displayed when frequency and designator is stored in the favourite list

	User & Installation manual VHF- Communication Transceiver	Doc.-Nr: DE-3000-800100e
	KRT2 & KRT 2A	Revision 9.6 For Software >5.00 Sept.2013

Display	Meaning	Remark
DUAL	Active frequency AND Standby Frequency are monitored simultaneously	DUAL function is deactivated by frequency change or by pressing the DUAL button again
[03] (MEMORY)	Favourite list index (0-99)	When frequency and designator are stored at this index they are displayed
125.100 _{upper}	Active - frequency	
134.825 _{lower}	Standby - frequency	
<	The pointer indicates what the turning knob will change VOL SQ VOX.....etc Standby frequency	Arrow is positioned in correspondence to the button pressed (AUD or FREQ)
BAT	Supply voltage is low <10,5V	Battery low or Battery/Generator faulty
Er_ANT	Antenna error	Bad antenna match
a v e	Status of certain Audio menu functions	a = AUX. Input active v = VOX active e = external Intercom switch active
Er_PLL	Internal error, no transmission	Return the transceiver for maintenance
Er_ADC	Internal error,	Return the transceiver for maintenance
Er_FPA	Internal error; unit not usable	Return the transceiver for maintenance
Er_I2C	Internal error; unit not usable	Return the transceiver for maintenance
Er_si53	Internal error; unit not usable	Return the transceiver for maintenance
Er_D10	Internal error; reception corrupt	Return the transceiver for maintenance
Key_Block	Internal error; unit not usable	Return the transceiver for maintenance

	User & Installation manual VHF- Communication Transceiver	Doc.-Nr: DE-3000-800100e
	KRT2 & KRT 2A	Revision 9.6 For Software >5.00 Sept.2013

4 OPERATION

4.1 General

In the normal operating mode in which the turning knob always is connected to the volume (VOL). The normal operating mode can be left by pressing the AUD, FREQ or MEMORY button.

When not in the normal mode and there is no pilot action for more than 10 seconds the unit returns to the normal mode.

4.2 ON / OFF Switching

ON / OFF switching is by the self-locking push switch.

After power up the following display will be displayed:



Device-name

KRT2

Software-

Version

e.g. V2.0

KRT2

Software-

Version

e.g. V2.0

The unit then starts in the normal operating mode using and displaying the data last used.

4.3 Frequency Selection

There are two different frequency selection methods:

- Direct Input
- Selection from the favourite list (index 0-99)

	<p>User & Installation manual VHF- Communication Transceiver</p>	<p>Doc.-Nr: DE-3000-800100e</p>
	<p>KRT2 & KRT 2A</p>	<p>Revision 9.6 For Software >5.00 Sept.2013</p>

4.3.1 Direct Frequency Selection



The Standby-Frequency is set with the turning knob in 3 different ranges. The selected range is highlighted and can be changed with the **FREQ** button.

Frequency ranges are: 1xx.nnn
1nn.xnn
1nn.nxx

Press the **FREQ** button once or several times until the desired frequency range is highlighted.

When the pointer is not next to the Standby Frequency window, it will be repositioned with the first pressing of the **FREQ** button.



Exchanges the Active and Standby frequencies.

When the Exchange button was not pressed, the Standby frequency display will return to its normal appearance after 20 seconds.

4.3.2 Frequency Selection from the Favourites List



By pressing  and operating the turning knob a specific favourite list position can be accessed [xx] (xx = index 0 ... 99). When frequency and station designator have been defined, they will be displayed in the Standby and station designator windows.

	User & Installation manual VHF- Communication Transceiver	Doc.-Nr: DE-3000-800100e
	KRT2 & KRT 2A	Revision 9.6 For Software >5.00 Sept.2013

The favourite list designators can be sorted in alphabetic order (see 3.3.3).



Exchanges the Active and Standby frequencies.

The selection procedure can be terminated with either the AUD or FREQ buttons. Without pressing any of these buttons the unit will return to its normal operating mode after 20 seconds.

4.3.3 Storing and Editing Favourites

Any displayed Standby Frequency can be given a designator and both can be stored together as favourites in the favourite list. Both the frequency and designator of a favourite can be edited.



First press  button and by means of the turning knob go to the desired favourite list position which may be empty or the favourite to be edited (index [00 ...99]).

Press the MEMORY button a second time and „-EDIT-“ will show up in the program window.

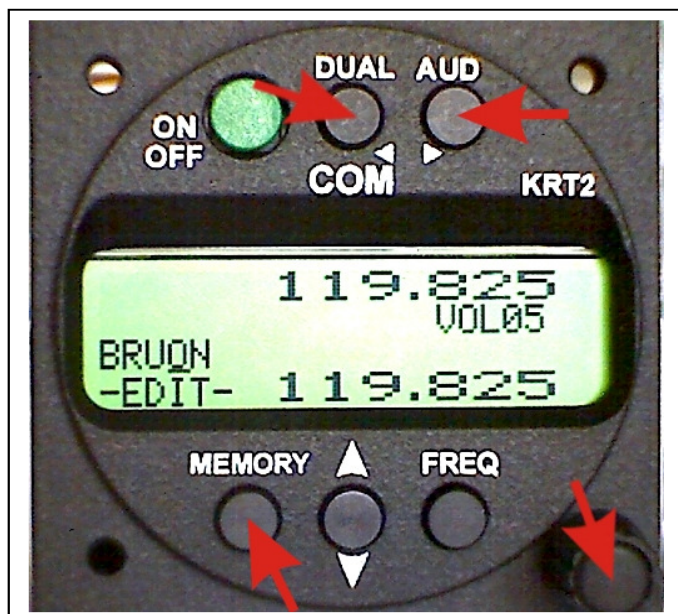

In the designator window a blinking cursor will show up under the extreme left character.

The turning knob selects the desired character.

The AUD button positions the cursor one character to the right. The DUAL button positions the cursor one character to the left and simultaneously erases this character.

The station designator can consist of maximum 8 characters.

Press the FREQ button and follow the normal direct input procedure to edit the frequency.

	User & Installation manual VHF- Communication Transceiver	Doc.-Nr: DE-3000-800100e
	KRT2 & KRT 2A	Revision 9.6 For Software >5.00 Sept.2013

To quite the frequency input press the MEMORY button again in order to go to the station designator window for editing the designator if required. Using the buttons FREQ and MEMORY it can be toggled any time between designator and frequency input. Keep in mind the watch dog timer which will terminate the input mode after 20 sec.

Termination / save firmware version 6.14 and after:

Terminate just by pressing  , for short time I appears "SAVE" and the system goes back into favourite selection.

A **sorting process** can be activated by pressing again MEMORY from EDIT-mode.

SORT? will show up which stays for 20 seconds and it should be activated by  or skipped by MEMORY.

When activated all 99 favourites will sorted in alphabetical order which can take several minutes.

During the sort procedure „RUN nn“ is displayed in the program window, with nn being the running index.

After skip or end of sort the transceiver then resumes the normal operating mode.

When the MEMORY button is pressed during the time when „RUN nn“ is displayed the sorting procedure is terminated. The favourite list then is sorted partially only and the transceiver resumes the normal operating mode.

	User & Installation manual VHF- Communication Transceiver	Doc.-Nr: DE-3000-800100e
	KRT2 & KRT 2A	Revision 9.6 For Software >5.00 Sept.2013

Termination / save firmware version before 6.14:

In EDIT-mode pressing MEMORY again terminates editing and SAVE?  will show up.

SAVE? is available for 20 seconds and must be acknowledged by the  button. No acknowledgement within 20 seconds results in the termination of the storing procedure.

Further favourites can be stored or edited by following the normal input procedure.

For time saving purposes it is recommended to initiate the sorting procedure after the last favourite has been saved or edited.

Example (Vers < 7.00) :

Button MEMORY -> [23] = select location

Button MEMORY -> -EDIT- = entry for name & frequency

Rotating knob + Cursor-buttons

Button FREQU -> frequency setting.....

Use MEMORY to go back to -EDIT-

Button MEMORY -> SAVE ? = now with use  to save it (do nothing for cancelling)

After save it comes the question for sorting: Yes = , No = MEMORY or do nothing.

	User & Installation manual VHF- Communication Transceiver	Doc.-Nr: DE-3000-800100e
KRT2 & KRT 2A		Revision 9.6 For Software >5.00 Sept.2013

4.4 AUD – Audio Menu

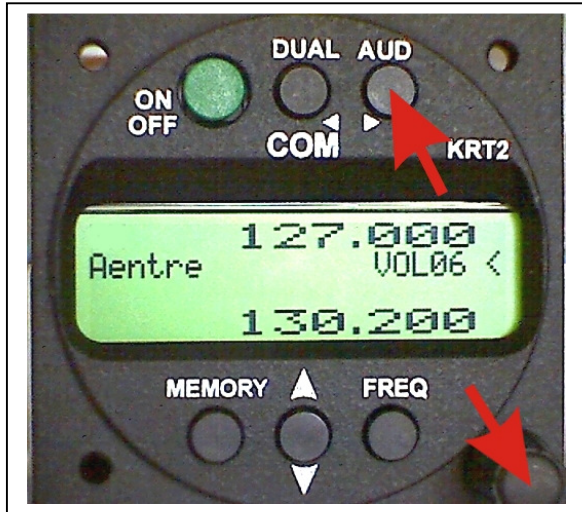

Any action in the Audio Menu requires the pointer (<) to be next to the Audio menu window (see picture). When the pointer is next to the Standby frequency window, the pointer can be repositioned by pressing the AUD button once.

VOLnn is the Audio menu default display. No action on any control for more than 10 seconds will result in the VOLnn display.

Audio Menu items can be accessed in the following order by repeatedly pressing the AUD button.

VOL (default) SQ VOX TXm** INT EXT DIM CON SIT MIC

Audio menu items to right of the above list are less used than the left ones.

4.4.1 VOL – Volume

Turning the turning knob changes the receiver volume.

VOLnn

Range: 01 - 16

	The VOL setting only concerns the receiver and not the intercom system. Intercom volume values are set in the INT audio menu.
---	---

4.4.2 SQ -- Squelch

Pressing the AUD button once enables the turning knob to change the squelch level values.

SQnn

Value range: 01 – 10

The Squelch setting is depending on several factors.

	User & Installation manual VHF- Communication Transceiver	Doc.-Nr: DE-3000-800100e
	KRT2 & KRT 2A	Revision 9.6 For Software >5.00 Sept.2013

For engine driven airplanes an initial setting of 05-08 is recommended. Gliders may need a lower setting. The lower the Squelch level value the higher is the input sensitivity. A high sensitivity setting is susceptible to noise from other sources like ignition strobe-lights etc.

	Standard SQ-level is 05 ... 08. Higher setting will suppress weaker input signals. 01 = Squelch off, 02 = for long range. Squelch does not influence the intercom system.
---	---

4.4.3 VOX – Intercom Voice Trigger Level Setting

Pressing the AUD button twice enables the turning knob to change the voice level which triggers the intercom.

The intercom voice trigger level must be set to such a value which prevents that normal cockpit noise being heard in the earphones. The intercom system should only be activated when talking at a normal voice level into the microphone.

The higher the trigger level the louder the voice must be in order to trigger the intercom system.

VOX on condition is indicated by flag “v”.

VOXnn

Range: 01 – 10

4.4.4 Manual Intercom

In case of extreme cockpit noise or uncompensated microphones the Intercom can be controlled manually by using an external switch.

Therefore the VOX system must be activated permanently by selecting VOX: 01.

To turn off the Intercom the talk switch (default closed) must be opened, which will be indicated by “e”.

The manual Intercom turnoff only works by a deactivated external audio input.

For use in gliders the VOX has to be set >1 (use 5), because VOX=1 turns off the speaker.

	User & Installation manual VHF- Communication Transceiver	Doc.-Nr: DE-3000-800100e
	KRT2 & KRT 2A	Revision 9.6 For Software >5.00 Sept.2013

4.4.5 TXm – PTT Switch Selection

Pressing the AUD button three times enables the turning knob to enable certain PTT switches.

On transmission only that microphone will be enabled which is related to the PTT-L/R.

TXm** *- Left / -* Right / ** Both

4.4.6 INT – Intercom Volume

Pressing the AUD button four times enables the turning knob to set the intercom volume.

INTnn Range: 01 - 10

4.4.7 EXT – External Audio Input Volume

Pressing the AUD button five times enables the turning knob to set the external audio input volume. External audio inputs can be audio alarms, voice alarms, music etc. Required level is 200mVpp.

Activation occurs for settings >00 and will be indicated by the flag “a”.

The setting 00 is turning off this input.

EXTnn Range: 00 - 10

4.4.8 DIM – Display Brightness (Batt.-voltage)

Pressing the AUD button six times enables the turning knob to set the display brightness.



Display lighting current drain at maximum brightness is only 10mA. Maximum brightness is glare free even in darkness and can be used continuously.

Indication of battery voltage (VDC).

DIMnn Range: 01 – 10

4.4.9 CON – Display Contrast

Pressing the AUD button seven times enables the turning knob to set the display contrast.

CONnn Range: 01 - 10

	User & Installation manual VHF- Communication Transceiver	Doc.-Nr: DE-3000-800100e
	KRT2 & KRT 2A	Revision 9.6 For Software >5.00 Sept.2013

4.4.10 SIT – Side tone

Pressing the AUD button eight times enables the turning knob to set the side tone volume.

SITnn

Range: 0 – 9

4.4.11 MIC – Setup

This mode is for service only, normal operation is not possible in this mode.

Each of the two microphone input channels can be configured individually, which enables different microphone types to be used.

A maximum of two microphones of same type may be connected to each microphone input channel (see Microphone Connection 5.6.1).

The MIC – Setup is the last item of the Audio menu and can be accessed by pressing the AUD button nine times.

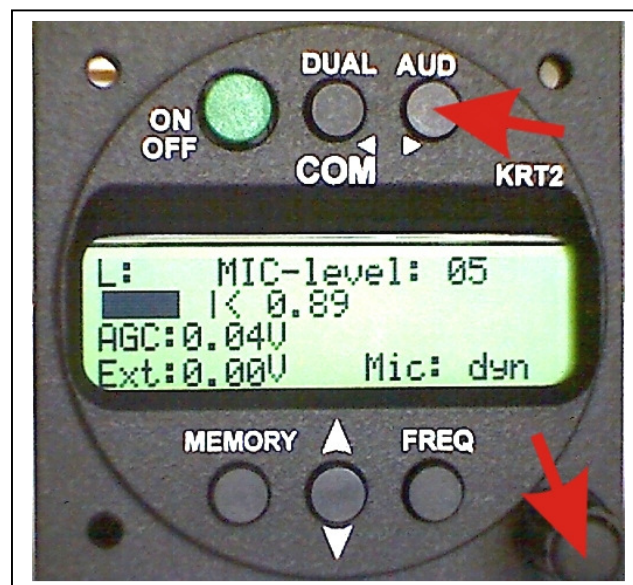

By pressing the DUAL button repeatedly L, R and AUTO can be selected. L (R) means left (right) microphone input channel. The AUTO function is explained later.

By means of the turning knob the displayed microphone input channel amplifier gain (MIC-level-01==low-gain,-09==high-gain) can be selected individually. The microphone signal level is dynamically displayed as bar and as numeric value (from-0.00-to-1.00) in the line below.

	User & Installation manual VHF- Communication Transceiver	Doc.-Nr: DE-3000-800100e
	KRT2 & KRT 2A	Revision 9.6 For Software >5.00 Sept.2013

The initial MIC-level should be 05, the engine should be running, use a headset or earphone and speak at a normal voice level to fine-tune the MIC-level. Whenever a new MIC-level is selected, the dynamic bar indicator should then be at about 50%.

When the microphone setup menu is terminated, the new value is stored.

To activate AUTO the menu should be terminated with this selection, else leave in L or R position.

The range of the MIC-level for standard microphones is 01 to 09. MIC levels 10 and 11 are special settings for low microphone levels like dynamic micro-phones often used in gliders.

Those levels are valid for the left (L) input only.

10 is used for non-amplified Electret microphones with a 8 volt supply voltage.

11 is for dynamic microphones only.

In the AUTO mode (up to Firmware version 6.16 every 30 sec. then at transmission start) the **left** microphone impedance is measured. When using an Electret microphone but a dynamic microphone is recognized, internal switchover to the dynamic microphone type and vice versa will take place. When using a dynamic microphone and an Electret microphone is recognized, internal switchover to the Electret microphone type will take place. For the dynamic microphone the gain value 11 will be set for **L**. If Electret is recognized the presented values will be set.



The present recognized type will be updated (Mic: dyn/std) only if the mic.-setup is re-entered.

For the std-part the previous individual setup is stored when the menu was leaving.

The MIC submenu is terminated by pressing the AUD button.

Additional indications

Additional indications for test purposes:

	User & Installation manual VHF- Communication Transceiver	Doc.-Nr: DE-3000-800100e
	KRT2 & KRT 2A	Revision 9.6 For Software >5.00 Sept.2013

RxS: RF receiver input level (from Automatic Gain Control)

Ext: External audio input voltage

Mic: dyn or Mic: std

Display indicates, which microphone type has been selected after entering the mic.-menu.

After firmware 6.17 or 7.02:

This Symbol  appears on right side of STBY-Frequency in AUTO-mode if the dynamic microphone has been recognized and activated after transmission.

4.4.12 Menu locking

For school operation the menus area TXm to MIC-setup can be locked.

To lock or unlock the button combination AUD & FREQ has to be pressed simultaneously.

In lock condition there will be displayed at the right end of the third line a „L“.

The condition persists after turn off/on.

	User & Installation manual VHF- Communication Transceiver	Doc.-Nr: DE-3000-800100e
	KRT2 & KRT 2A	Revision 9.6 For Software >5.00 Sept.2013

4.5 DUAL Watch

Because the communication transceiver KRT2 contains only one receiver, DUAL watch is achieved by alternating between the Active and Standby frequencies.

The DUAL button activates and deactivates the dual watch function. Deactivation also can take place by pressing either the **FREQ** or **MEMORY** buttons.

The frequencies to be watched should be selected prior to the DUAL watch selection.

Scanning of frequencies is only possible when differentiating between radio noise and radio transmissions. This can be achieved with the squelch system set to a value of 02 or higher.

	There must be radio noise suppression in order to recognize reception. SQ must be 02 or higher.
--	---

When DUAL watch is activated, "DUAL" is displayed on the lowest line. The pointer next to the DUAL display indicates the frequency on which there is reception.

The Active frequency always has priority, so the receiver remains on the Active frequency as long as there is reception on the Active frequency.

When there is no reception on both the Active frequency and the Standby frequency the receiver scans both frequencies 5 times per second.

When there is reception on the Standby frequency the receiver stays on the Standby frequency, however it switches to the Active frequency every 2 seconds for 0.3 seconds. When reception is detected on the Active frequency the receiver stays on the Active frequency.

The pointer next to the DUAL display indicates on which frequency there is reception.

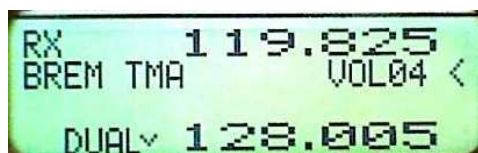
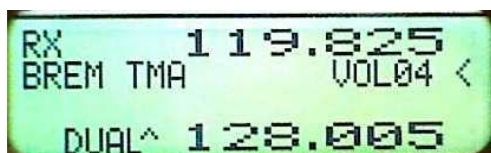

	User & Installation manual VHF- Communication Transceiver	Doc.-Nr: DE-3000-800100e
	KRT2 & KRT 2A	Revision 9.6 For Software >5.00 Sept.2013

Active-frequency-reception

Standby-frequency-reception

Standby and Active frequencies can be exchanged when in the DUAL mode. The transmitter operates on the Active frequency only.

Summary:

- Select the Standby frequency to be monitored in addition to in use frequency.
- With the AUD button and turning knob set SQnn to 02 or higher.
- With the DUAL button activate the DUAL watch function.
- When there is no reception on both the Active frequency and the Standby frequency the receiver scans both frequencies 5 times per second.
- When scanning the Active frequency always has priority.
- Deactivate the DUAL watch function with the DUAL or FREQ or MEMORY buttons.

4.6 Transmitter Operation

	User & Installation manual VHF- Communication Transceiver	Doc.-Nr: DE-3000-800100e
	KRT2 & KRT 2A	Revision 9.6 For Software >5.00 Sept.2013

The unit transmits on the active frequency (upper line) as long as a PTT (press to talk) switch is pressed.



Transmission



Reception

„TX“ indicates normal transmitter operation.

In the lower left corner of the display the carrier modulation is dynamically displayed. It corresponds to the side tone which is not available on gliders when no earphones are in use.

In order to avoid the blocking of the frequency by unintentional long transmissions (stuck microphone) the transmitter is switched off after two minutes and the display changes from „TX“ to „Te“. To resume transmission the PPT switch first must be released and then be pressed again.

While transmitting the external audio input will be turned off automatically. The microphone selection is dependant upon the pre-setting of the TXm-activation.

The differential speaker output will be turned off to prevent an audio feedback to the microphone. The speaker also will be disabled if the intercom (VOX) is active.

The output for the headset will carry the side tone.

	User & Installation manual VHF- Communication Transceiver	Doc.-Nr: DE-3000-800100e
	KRT2 & KRT 2A	Revision 9.6 For Software >5.00 Sept.2013

4.7 Self test monitor

Operating in the background continuously there is a back ground test system.

The field for battery status & error (see Control Elements Overview) is used to indicate warnings and in the case of hardware failure, different error reports be displayed there.

The warnings are:

BAT low battery voltage (becomes active < 10,5V)

At transmission

A-match bad antenna match or antenna defective.

Also while transmitting the TX-flag (left top) will change to

Te if transmission time has exceed (> 2 minutes)

All other reports starting with Er.... Indicating a major hardware failure and consequently the radio has to be returned to the factory.

4.7.1 Optical side tone

Especially when used in gliders, where headsets are generally not worn and thus no side tone is heard, it is very helpful to see if the microphone is working. The KRT 2 solves this problem

At left lower side, there is a modulation indicator that depicts the voice level. When there is no modulation it becomes a small dot approximately in the centre.

Also if it far off centre, it indicates that there is bad antenna matching.

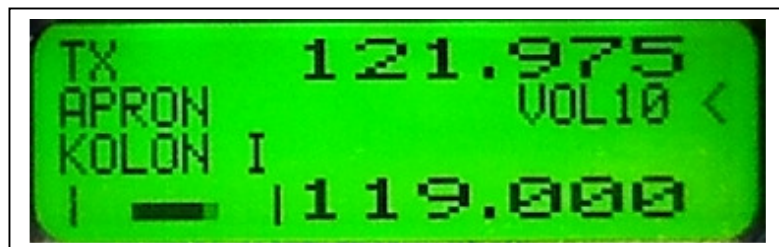

	User & Installation manual VHF- Communication Transceiver	Doc.-Nr: DE-3000-800100e
	KRT2 & KRT 2A	Revision 9.6 For Software >5.00 Sept.2013

4.8 Resetting to factory settings

Returning to the factory settings can only be initiated during power-up.

To do this, during power-up the MEMORY and DUAL buttons must be pressed simultaneously and the display will show “SET DEFAULTS”. When the buttons are released the resetting to the factory settings takes place. When resetting is completed “DONE” is displayed.

Resetting to the factory settings will not change any data in the favourite list memory.

	User & Installation manual VHF- Communication Transceiver	Doc.-Nr: DE-3000-800100e
	KRT2 & KRT 2A	Revision 9.6 For Software >5.00 Sept.2013

4.9 SET UP - Menu

During power-up the MEMORY buttons must be pressed

There are two functions within the Set-up menu:

- ERASE – Erasing of the favourites (frequency and designator)
- Channel Spacing – 25kHz / 8,33kHz

Programming of the Set-up is done with the lower 3 buttons. Their function is described on the display.

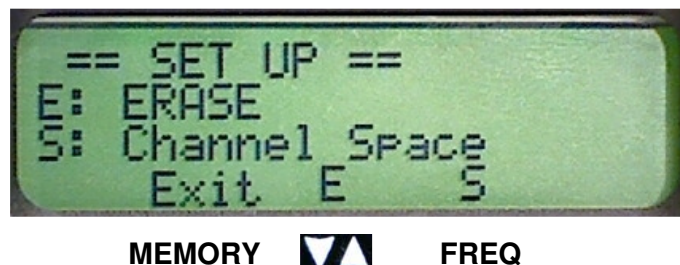



Set-up program exit is with the MEMORY button. The unit remains powered and the normal operating mode is resumed.

Remark:  = 

4.9.1 ERASE – Erasing the Favourites List

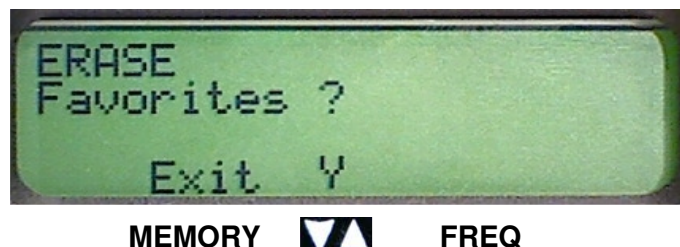
When in the SET UP – Menu select the “ERASE“ submenu with the .



Erasing the favourites (frequency and designator) starts after the  button was pressed again. This procedure may last a few minutes during which time “ERASING“ is displayed.

All INFO frequencies and designators that were stored on delivery are lost and all favourite index positions (01 to 99) are available to the user.

	User & Installation manual VHF- Communication Transceiver	Doc.-Nr: DE-3000-800100e
	KRT2 & KRT 2A	Revision 9.6 For Software >5.00 Sept.2013

4.9.2 Channel Spacing

When in the SET UP – Menu pressing the **FREQ (S)** button will change the KRT2 into the Channel Space submenu.



MEMORY  **FREQ**

The desired channel spacing then can be selected and the (X) then indicates the actual channel spacing.

5 Remote Control

Tandem-seat airplanes can be equipped with the KRT2RC Remote Control Unit. The remote control unit is connected to RS232 serial interface and enables selection of the most common settings like frequency, volume, squelch, VOX, display contrast and brightness. In addition the unit has an independent memory for favourites (frequency and designator).

Transmission error messages are displayed in the error window in the third line

R_Time = Time-out transmission error
R_ChkS = Checksum error
R_Cmd = Unknown command
R_Char = Data error
R_Freq = Wrong Frequency

The error message disappears when a valid command or a new frequency has been input, latest however after 5 seconds.

Remote control unit errors do not interfere with the KRT2 transceiver operation.

Data transmission between the transceiver KRT2 and the remote control unit (KRT2-RC) is checked once every minute. A “r” in the upper right

	User & Installation manual VHF- Communication Transceiver	Doc.-Nr: DE-3000-800100e
	KRT2 & KRT 2A	Revision 9.6 For Software >5.00 Sept.2013

corner is displayed when there is no malfunction.

The KRT2-RC can also operate the KRT2 in a fully stand-alone mode such the KRT2 can be installed anywhere in the aircraft and be operated remotely by the KRT2C. This feature will be useful in tandem aircraft, or aircrafts with very little space behind the instrument panel

	User & Installation manual VHF- Communication Transceiver	Doc.-Nr: DE-3000-800100e
	KRT2 & KRT 2A	Revision 9.6 For Software >5.00 Sept.2013

6 Installation

6.1 Installation Hints

The following hints should be considered for installation.

A certified maintenance shop should perform the wiring (or as required by local national regulations). For the wiring diagram refer to chapter 5.7.3

6.2 Telecommunication Data

The following data may be required for the radio station licence.

Manufacturer	AIRplus Maintenance GmbH
Type	KRT2
EASA Number	P/N 100-90001-00
Power Output	6 W
Frequency:	118,000 – 136,975 MHz
Emission Designator:	6k00A3E für 25khz channel spacing 5k00A3E für 8,33kHz channel spacing

6.3 Scope of delivery

Part Number	Description
KRT2	KRT2 - VHF Transceiver
ZUB2 (3 pcs)	Mounting screw KRT2 - for panels up to 3mm
.....	Operation and Installation Manual
	EASA Form 1

	User & Installation manual VHF- Communication Transceiver	Doc.-Nr: DE-3000-800100e
	KRT2 & KRT 2A	Revision 9.6 For Software >5.00 Sept.2013

6.4 Unpacking and Inspecting the Equipment

Carefully unpack the equipment. Damages due to transportation must immediately be reported to the shipping company. Save the shipping container and all packing material to substantiate your claim.

	For storage or reshipment the original packing material should be used..
---	--

6.5 Mounting

- In cooperation with the maintenance shop, mounting details are specified. The maintenance shop can manufacture and install all cables that may be required..
- Avoid installing the unit in the vicinity of heat sources. Sufficient air-circulation is required.
- There must be sufficient space for cables and connectors.
- Avoid sharp bends and wiring close to control cables.
- Cable length must be such that connectors are accessible for repair.
- The wiring to the transceiver must be installed such that water droplets formed by condensation will not run into the connector.
- Remove the turning knob in order to install the transceiver:
 - Remove the turning knob cap with an appropriate tool.
 - Loosen the screw and remove the turning knob.
 - Install cap correctly oriented!
- Installation is from the front side of the instrument panel with three 4mm screws in a 57mm panel cut-out.
- For installation details and drawings refer to chapter 5.7

	User & Installation manual VHF- Communication Transceiver	Doc.-Nr: DE-3000-800100e
	KRT2 & KRT 2A	Revision 9.6 For Software >5.00 Sept.2013

6.6 Electrical Connections

The 15-pin D-Sub connector contains all electrical connections except the antenna.

	The battery plus connection must be protected with at least 3-amps slow blow fuse !
---	---

6.6.1 Microphone-Connection

Both the L (left) and R (right) microphone input channels can either be connected to standard microphones (standard signal level 1Vpp) or to dynamic microphones (standard signal level 5mV to 10mV). R has less sensitivity (30mV).

For standard microphones a supply voltage of 8V at 330Ω is provided.

Elementary Electret microphones can also be connected. They have considerably lower signal levels and therefore require an 8V supply voltage.

The microphone input channel amplifier gain can be selected via the MIC-Setup menu 3.4.10.

When dynamic microphones are used in gliders the 8V supply voltage is switched off for power saving purposes.

Standard microphones normally used in headsets together with dynamic microphones generally cannot be used at the same time, just alternatively.

Motor gliders should have a toggle switch installed to differentiate between motor less flight with dynamic microphones and powered flight with headsets.

When the AUTO mode is selected in the MIC-Setup menu the KRT2 automatically recognizes on MIC-L (pin 3) which microphone type has been switched and acts accordingly.

Both inputs must not be wired together. L is the master. If R is not used it should be loaded or grounded and not be connected to open wires.

	User & Installation manual VHF- Communication Transceiver	Doc.-Nr: DE-3000-800100e
KRT2 & KRT 2A		Revision 9.6 For Software >5.00 Sept.2013

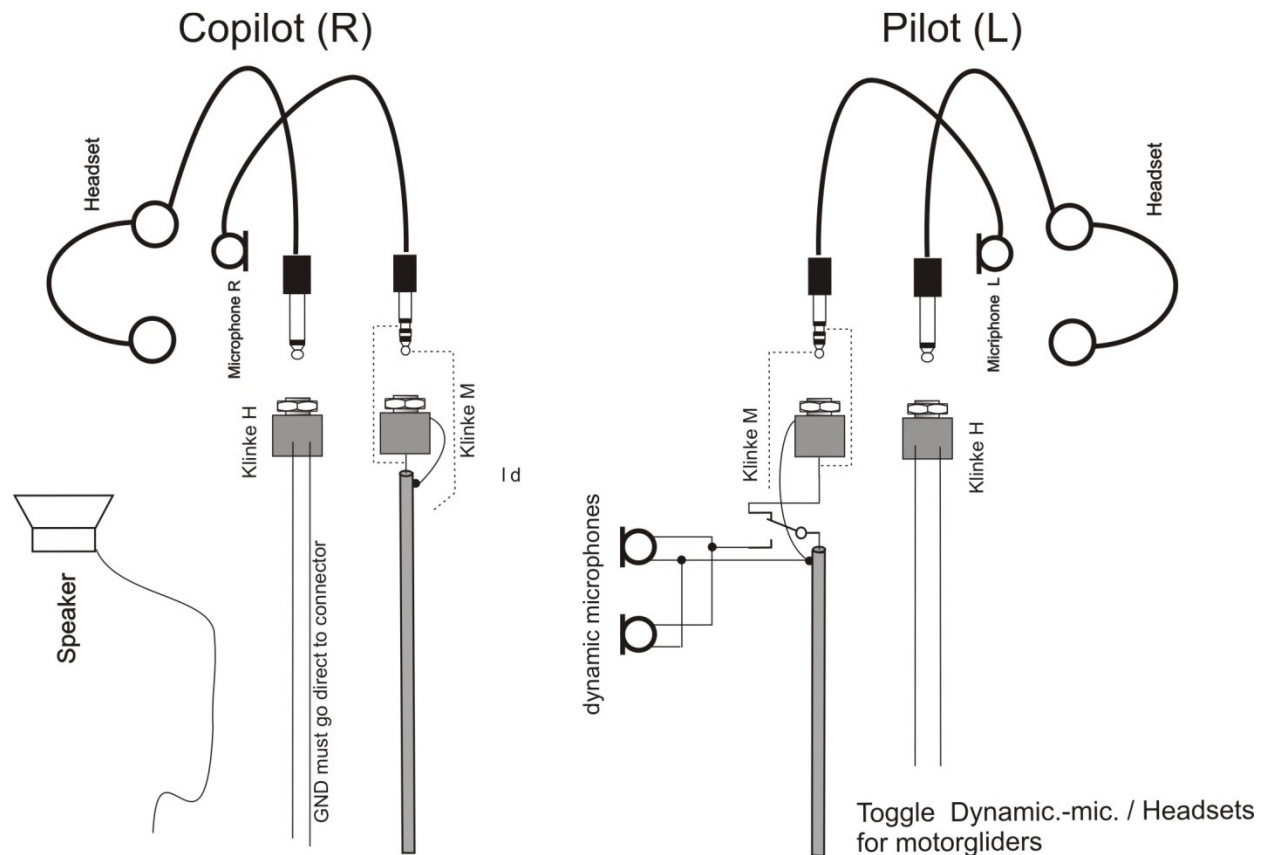

Because the 8V supply voltage is switched off when dynamic microphones are used during glider flight the second (copilot) headset microphone is disabled.

A maximum of two microphones of same type may be connected to each microphone input channel.

6.6.2 Earphone Connection

Several earphones of same type can be connected in parallel. The total impedance should not be less than 60 Ohms.

6.6.3 External Audio Input

Audio alarms or even music can be made available via the external audio input. When this input is not used it must be connected to ground in order to avoid noise. PIN5 must be connected to Battery minus (GND).

	User & Installation manual VHF- Communication Transceiver	Doc.-Nr: DE-3000-800100e
	KRT2 & KRT 2A	Revision 9.6 For Software >5.00 Sept.2013

6.7 Finally Audio-Setup

This is an overview for a correct audio set up depending on the usage.
Ground the unused MIC.-R input if unused.

6.7.1 For gliders

Press button AUD 3x for VOX: Set to VOX 10 (turn off).

Press button AUD 4x for TXm: Set to TXm**.

Press button AUD 6x for EXT: Set to EXT 00 (turn off).

Press button AUD 10x for MIC: Set to MIC-Level 11.

6.7.2 For motor gliders dual seaters

For change mode (motoring & headset – gliding & dynamic microphone)

Press button AUD 3x for VOX: Set to VOX 3.
on condition at motoring.

Press button AUD 4x for TXm: Set to TXm**.

Press button AUD 6x for EXT: Set to EXT 00 (turn off),
or on condition.

Press button AUD 10x for MIC: Set MIC-L to level 5 or as required,
Set MC-R as required or to 1 if unused.
select AUTO and leave menu.

6.7.3 Für Motor planes

Press button AUD 3x for VOX: Set to VOX 3 (turn off).

Press button AUD 4x for TXm: Set to TXm**,
or on condition.

Press button AUD 6x for EXT: Set to EXT 00 (turn off),
or on condition.

Press button AUD 10x for MIC: Set to MIC-Level 3 or as required
Set MC-R as required or to 1 if unused.

	User & Installation manual VHF- Communication Transceiver	Doc.-Nr: DE-3000-800100e
	KRT2 & KRT 2A	Revision 9.6 For Software >5.00 Sept.2013

6.8 Wiring

6.8.1 Wire Gauges

Supply lines (Power, GND): AWG18 (0,96 mm²)

Control lines: AWG22 (0,38 mm²)

All wires must be aviation certified.

6.8.2 Connector Pin-Configuration

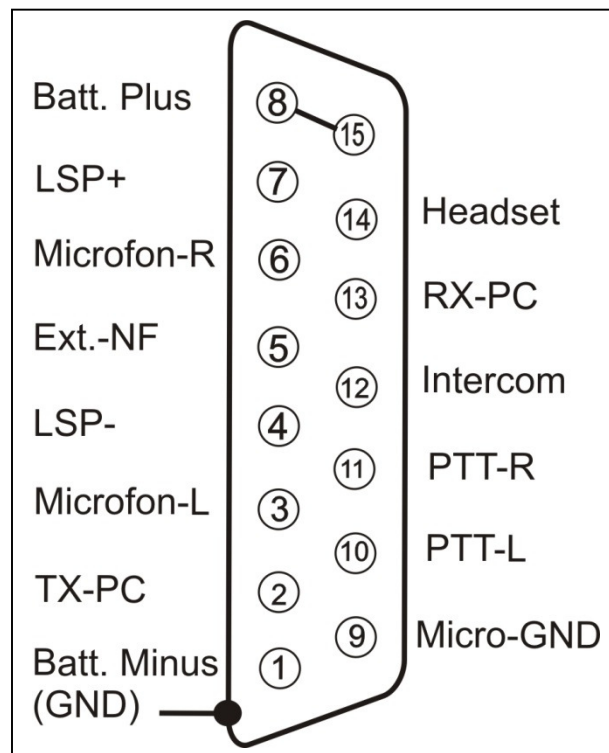

	If manual intercom is not used, pin 12 should be grounded.
---	--

	User & Installation manual VHF- Communication Transceiver	Doc.-Nr: DE-3000-800100e
	KRT2 & KRT 2A	Revision 9.6 For Software >5.00 Sept.2013

6.8.3 Wiring Diagram

6.8.3.1 Full connection

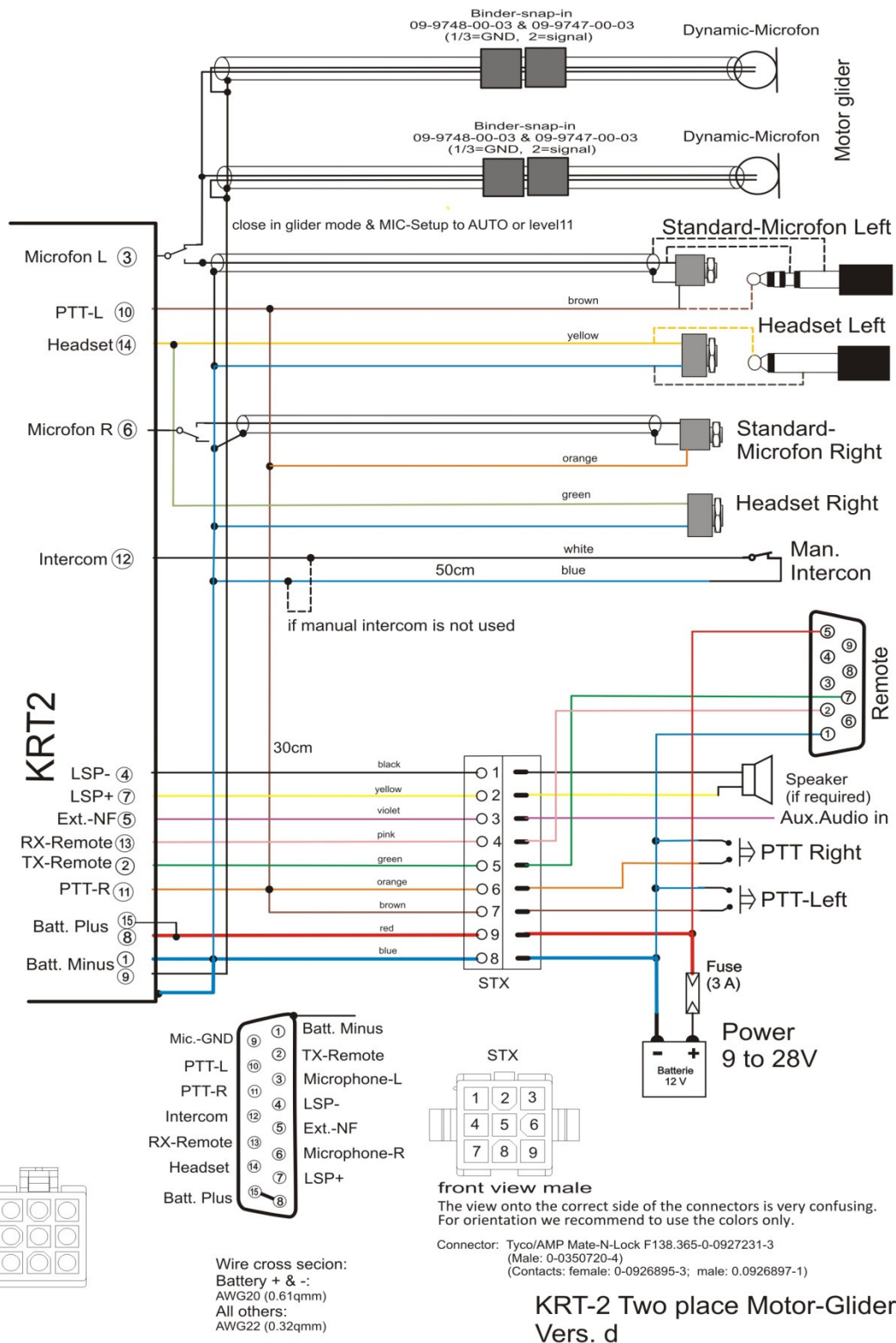

Microphone-Setup: R/L for Headsets, leave in AUTO mode

	<p align="center">User & Installation manual VHF- Communication Transceiver</p>	<p>Doc.-Nr: DE-3000-800100e</p>
<p align="center">KRT2 & KRT 2A</p>		<p>Revision 9.6 For Software >5.00 Sept.2013</p>

6.8.3.2 Glider single

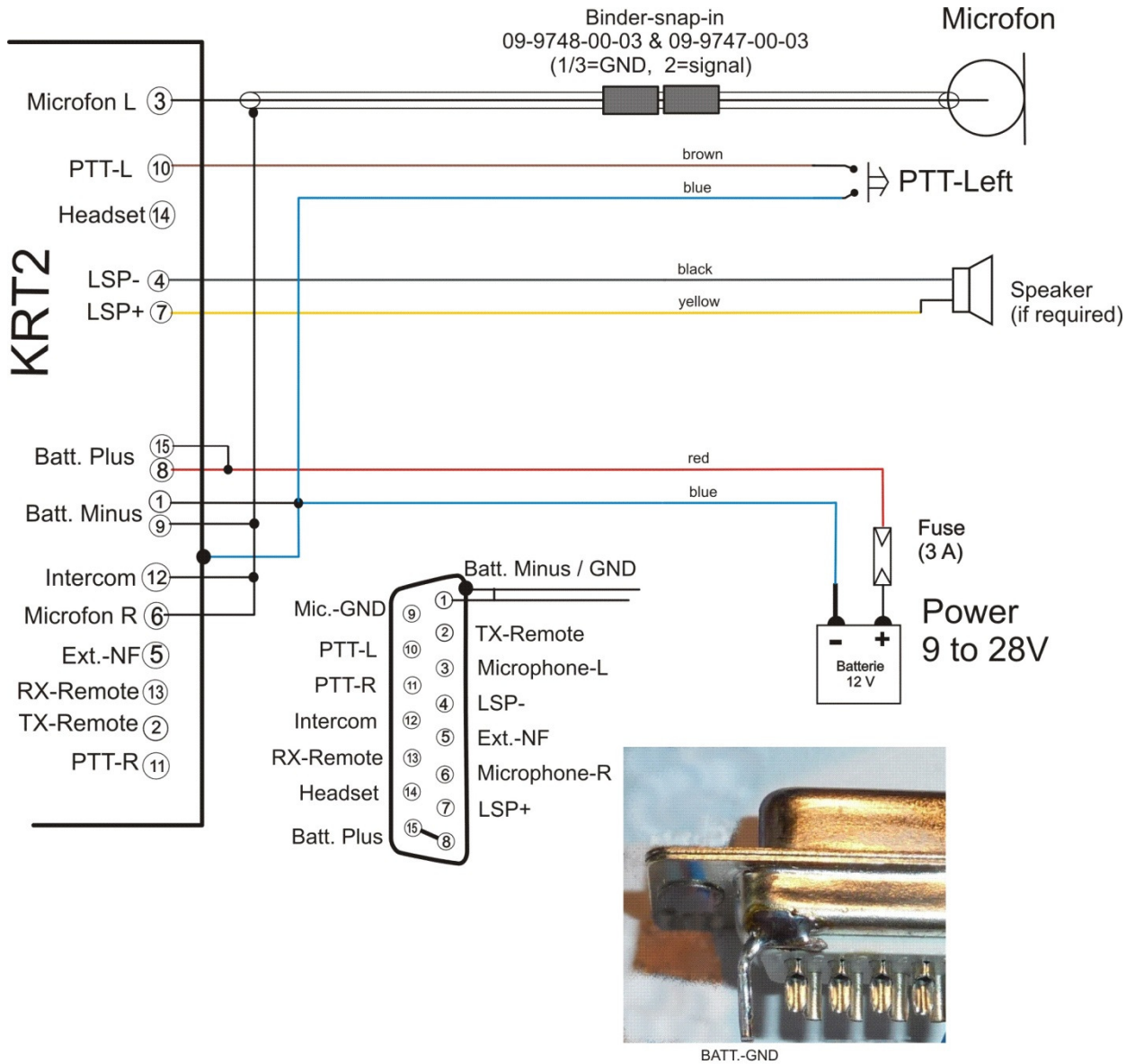

KRT-2 Glider-Single
V4b

Microphone-Setup: leave in L =11, (not AUTO)

6.8.3.3 Motor glider single

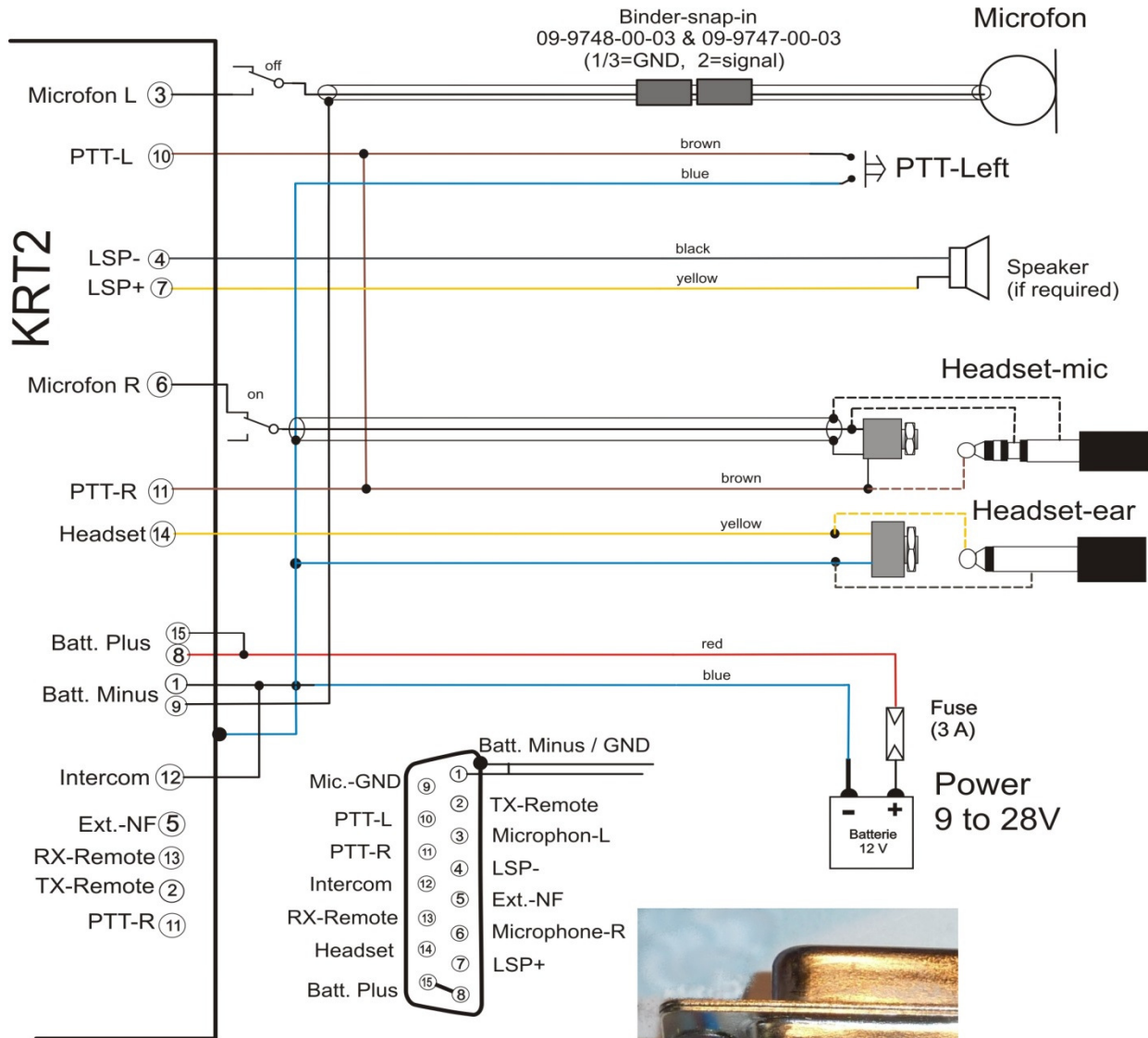

Alternative for Mic.-Selection:
Use PTT-L/R to select microphones instead of toggle switch.

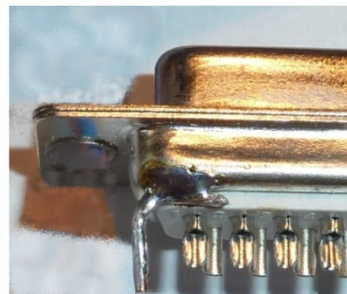

BATT.-GND

KRT-2 Motorglider-Single
V2

Microphone-Setup: leave in L = 11, R=3-6, (not AUTO)

6.8.3.4 Glider dual

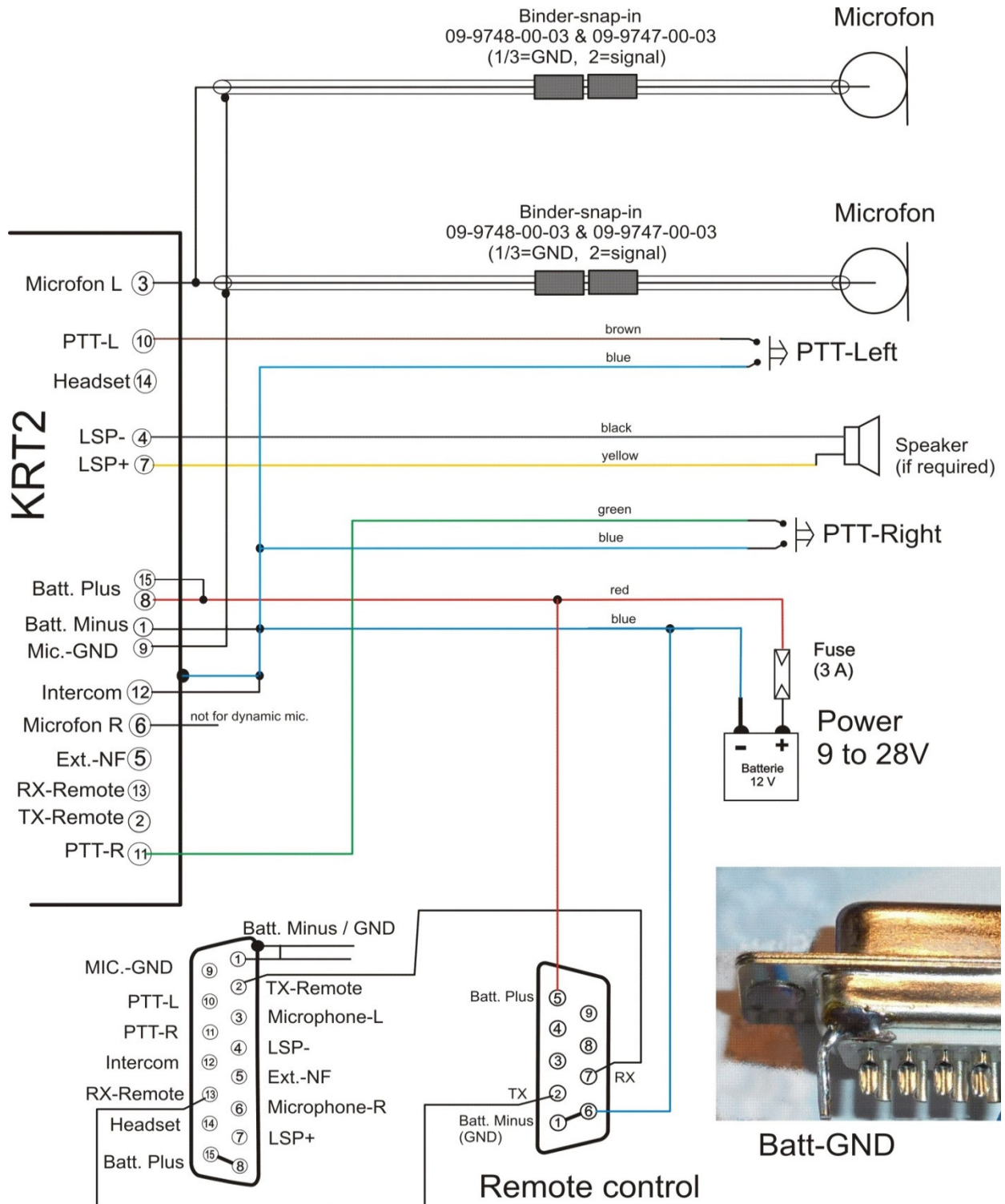

KRT-2 Glider-Dual
V3b

Microphone-Setup: leave in L =11, (not AUTO)

	User & Installation manual VHF- Communication Transceiver	Doc.-Nr: DE-3000-800100e
	KRT2 & KRT 2A	Revision 9.6 For Software >5.00 Sept.2013

6.8.4 Wiring for dynamic microphones

Special attention is required for the wiring for dynamic microphones. Because of the required high gain any mistake on the ground wiring leads to interferences and feed backs.

The basic rules are:

Never join power current grounds with the microphone ground.

The cleanest GND is the case of the radio.

Put the battery-GND to the case and the microphone-GND to the pins 1&9.

Alternatively it could be swabbed where the battery-GND is soldered to pin 1&9 and microphone-GND to the case.

6.8.5 Connection support

In order to connect shields of all cables at a single point and to avoid ground loops an adapter board as shown is recommended.

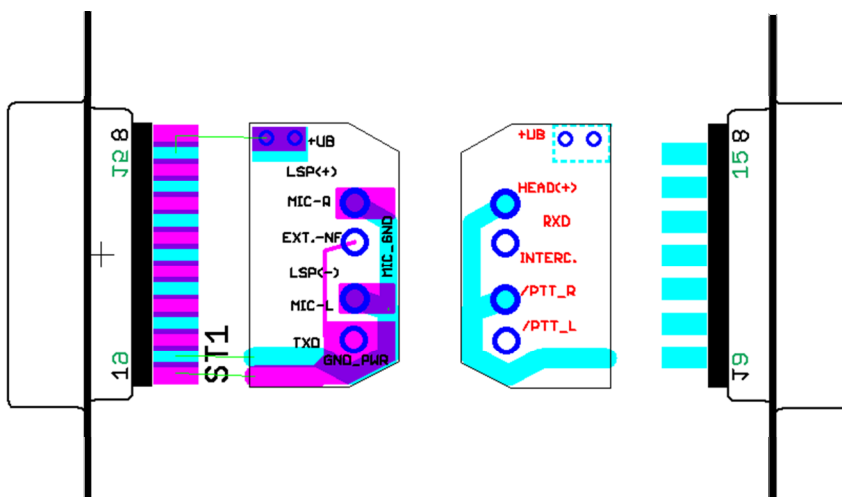

The adapter board is placed between the connector pin rows and soldered to the BAT plus pins 8,15 and GND pins 1 and frame. Pin 9 (microphone-GND) is provided on two pads for shielding. Further information printed on the board serves to connect all cables to its corresponding pins.

	User & Installation manual VHF- Communication Transceiver	Doc.-Nr: DE-3000-800100e
	KRT2 & KRT 2A	Revision 9.6 For Software >5.00 Sept.2013

6.9 Antenna

6.9.1 Antenna Selection

- A 50 Ohms impedance VHF-COM-antenna is required.
- The antenna must be approved in respect to aircraft type and installation location.
- The antenna specifications can only be fulfilled when properly installed

6.9.2 Installation Recommendation

- The manufactures instructions have to be observed.
- The metallic contact between airplane surface and antenna ground must be very good. Non-metallic airplanes must have installed a metal sheet, foil or mesh of at least 80×80 cm inside the fuselage as electric counterweight..
- In order to avoid interference the distance between a COM an NAV antenna or between a COM and another COM antenna should be as large as possible. A distance of 2 meters normally is sufficient.
- The antenna must be installed vertically and as far as possible away from parts like propeller, landing-gear, rudder etc., that may influence propagation of the radio signals.
- In gliders the internal antenna provided by the airplane manufacturer is to be used.



The RF-antenna cable may not be part of other cable sets like power-supply or microphone.
It must not be placed together with any other COM, NAV or transponder antenna cable.
THIS IS MOST IMPORTANT.

	User & Installation manual VHF- Communication Transceiver	Doc.-Nr: DE-3000-800100e
	KRT2 & KRT 2A	Revision 9.6 For Software >5.00 Sept.2013

6.10 Microphone general

The correct setting of the MIC and VOX values is of great importance for the Intercom system (see 3.4.3. VOX Intercom Voice Trigger Level and 3.4.10. MIC Setup).

The VOX intercom voice trigger level must be set to such a value that the intercom system is activated when speaking at a normal voice level into the microphone. It should be set so that it is triggered by normal cockpit noise.

When there is extreme cockpit noise or there are uncompensated microphones VOX should be activated with VOX=01 permanently and enable/disable by a manual intercom switch.

The manual intercom operation is possible with one or two separate, parallel connected, optional intercom switches. These switches are not the PTT switches. The intercom switches connect pin12 (intercom) with GND (pin1-and-9).

An “e” will be indicated if pin12 is not on GND.

Communication with the VOX system requires pin 12 to be connected to GND by means of one or two intercom switches.

The KRT2 unit **transmits** only when a PTT switch is pressed.

Cockpit noise suppression is only possible with differential microphones used in modern headsets. Normal Electret microphones are not suitable.

6.11 Post-Installation Check

	A certified maintenance shop must verify the proper operation of the VHF transceiver or as required by national regulations.
---	--

A complete check of all airplane systems is required to certify that the new wiring is not causing any malfunction.

	<p>User & Installation manual VHF- Communication Transceiver</p>	<p>Doc.-Nr: DE-3000-800100e</p>
	<p>KRT2 & KRT 2A</p>	<p>Revision 9.6 For Software >5.00 Sept.2013</p>

The standing wave ratio (SWR) must be less than 3:1.

A test flight is recommended to verify proper transceiver operation.

The following items should be checked:

- Check transceiver operation with a radio station at least 50 km away when at 2000ft or above.
- Check if there is unusual electrical interference or noise.
- If possible check the transceiver operation on low and high frequencies of the VHF frequency band.

6.12 Starting Up

Switch the unit on with the ON button.

The following display will appear:



The start display shows device type and the software number. It then changes into the normal operating mode (Direct Input).

	User & Installation manual VHF- Communication Transceiver	Doc.-Nr: DE-3000-800100e
	KRT2 & KRT 2A	Revision 9.6 For Software >5.00 Sept.2013

6.13 Accessories

Suitable accessories such as antennas, cable sets, and switches can be purchased at our online shop on www.AIRplus-avionics.com or from other avionics suppliers.

6.14 Drawings

6.14.1 Dimensions

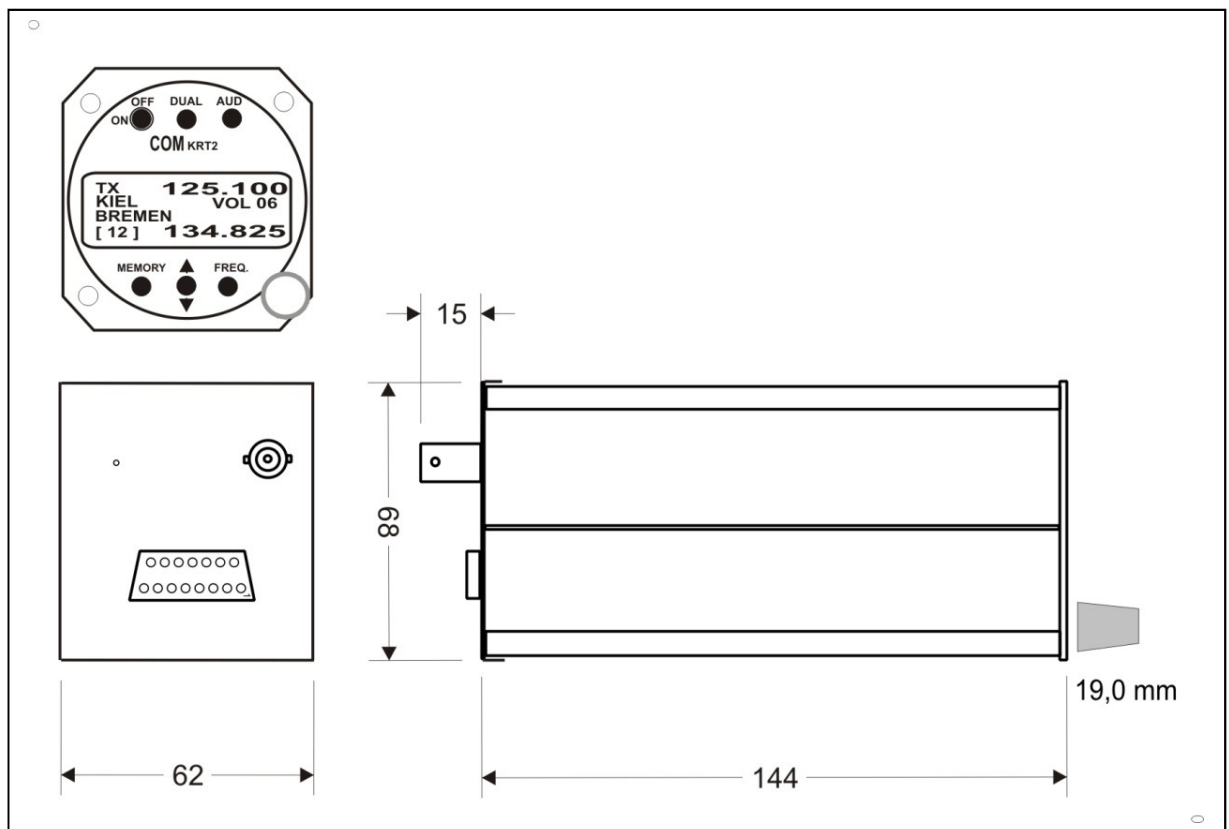

	<p>User & Installation manual VHF- Communication Transceiver</p>	<p>Doc.-Nr: DE-3000-800100e</p>
	<p>KRT2 & KRT 2A</p>	<p>Revision 9.6 For Software >5.00 Sept.2013</p>

6.14.2 Installation Directions

Connection Area

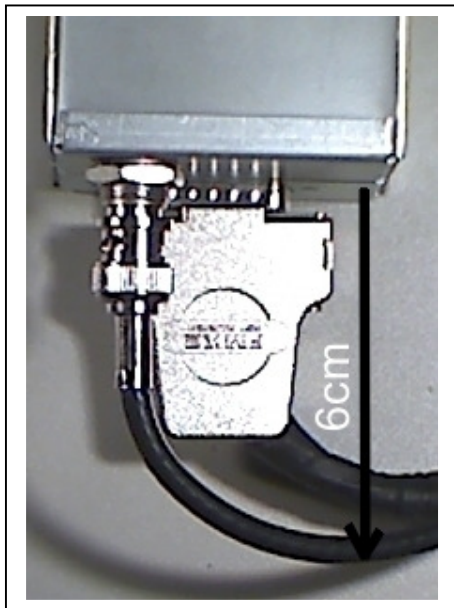

Panel Cut-out

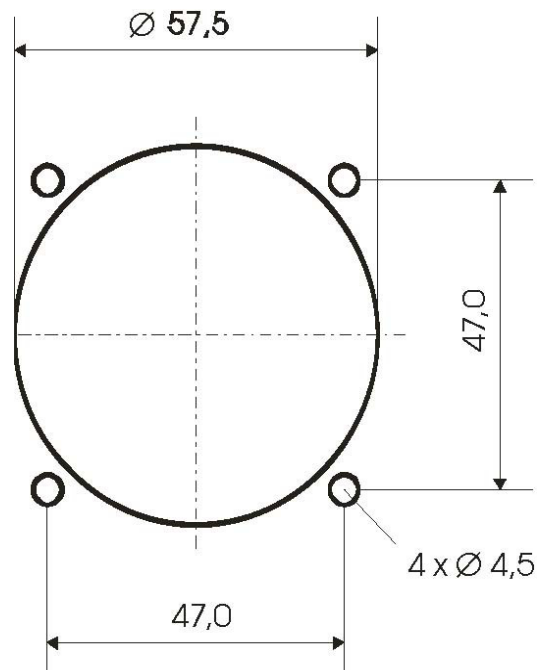

Mount / demount the rotation knob.



Never pull the button by force or press it onto the axis !

	User & Installation manual VHF- Communication Transceiver	Doc.-Nr: DE-3000-800100e
	KRT2 & KRT 2A	Revision 9.6 For Software >5.00 Sept.2013

7 Maintenance

7.1 Periodic Maintenance

No scheduled servicing tasks are required on the KRT-2 VHF unit.

7.2 Repair

Only exchange and flat repair of the equipment is permitted. In case of equipment failure, the unit must be sent to the manufacturer. Refer to section 1.3 Customer Service

7.3 Cleaning

Clean the display only with, lint-free cloth and an eyeglass lens cleaner that is specified as safe for anti-reflective coatings.

	User & Installation manual VHF- Communication Transceiver	Doc.-Nr: DE-3000-800100e
	KRT2 & KRT 2A	Revision 9.6 For Software >5.00 Sept.2013

8 ANNEX

8.1 Frequency / Channel- schedule

The following table contains the operating and displayed frequencies between 118.000 and... 118.100 MHz. The table can be continued up to 136.975 MHz following the same principle.

Operating frequency (MHz)	Cannel Spacing (kHz)	Displayed channel 8.33/25 kHz Mode	Displayed Channel 25 kHz Mode
118.0000	25	118.000	118.000
118.0000	8.33	118.005	
118.0083	8.33	118.010	
118.0166	8.33	118.015	
118.0250	25	118.025	118.025
118.0250	8.33	118.030	
118.0333	8.33	118.035	
118.0416	8.33	118.040	
118.0500	25	118.050	118.050
118.0500	8.33	118.055	
118.0583	8.33	118.060	
118.0666	8.33	118.065	
118.0750	25	118.075	118.075
118.0750	8.33	118.080	
118.0833	8.33	118.085	
118.0916	8.33	118.090	
118.1000	25	118.100	118.100
118.1000	8.33	118.105	
etc.	etc.	etc.	etc.

	User & Installation manual VHF- Communication Transceiver	Doc.-Nr: DE-3000-800100e
	KRT2 & KRT 2A	Revision 9.6 For Software >5.00 Sept.2013

8.2 Technical Data

GENERAL	
Compliance Standards	ED-23C Class 4-6 RTCA DO-186B Class 4 ED-23C Class C-D-E-H1/2 RTCA DO-186B Class H1/2 RTCA DO-178B/ED-12B Level D ETSO-2C169a
Standards	EUROCAE ED-23C RTCA DO-160E RTCA DO-178B/ED, Level D
Dimensions	Height: 68mm (after 2014: 62mm) Width: 62mm Depth: 144mm plus rear panel plugs 60mm
Weight	0.36 kg
Mounting	panel mounting, cut-out Ø 57 mm
Temperature Ranges Operation Storage	-20 °C to +55 °C -55 °C to +85 °C
Maximum Height	35000 ft
Vibration	DO-160E, Cat. S, Vibration Curve M
Humidity	RTCA DO-160E, Cat. A
Shock	6 G operation 20 G crash safety
RTCA DO-160F ENV. CAT.	[C1Z]CAA[SM]XXXXXXZBAAA[YY]M[B3F3]XXA
Power Supply	9 VDC to 33VDC test @ 12VDC <ul style="list-style-type: none"> • Transmitter: 2.0 A (typ.) • Receiver: 0.13 A • Illumination 0.02A • Audio Power amp. Up to 1A emergency operation: 9 VDC
Power Consumption	Standby 1.6W, Transmit 30 W
Frequency Range	118.000 .. 136.995 MHz
Frequency Stability	±5 ppm
Fuse	external fuse required: 4 A, slow-blow

	User & Installation manual VHF- Communication Transceiver	Doc.-Nr: DE-3000-800100e
	KRT2 & KRT 2A	Revision 9.6 For Software >5.00 Sept.2013

Compass Safe Distance	30 cm
------------------------------	-------

TRANSMITTER	
POWER OUTPUT	6 W (nominal) 4 W (minimal)
HARMONIC DISTORTION	<10 % at 70 % modulation
SIDETONE OUTPUT	>0,5W an 300Ω (head set output)
MICROPHONE INPUTS	2 x standard (50mV...2V) into 100Ω or 2 x dynamic
HARMONIC CONTENT	>60dBc
MODULATION FIDELITY	deviation <6 dB von 350...2500Hz
CARRIER NOISE LEVEL	>35dB at 70% Modulation index
UNWANTED FREQUENCY MODULATION	<1kHz at m=70% / 1kHz
DUTY CYCLE	2 minutes on, 4 minutes off; automatic turn-off after 2 minutes continuous transmitter operation
RECEIVER	
SENSITIVITY	-105 dBm (>6 dB S+N/N, m = 30 % / 1 kHz)
BANDWIDTH / 25 KHZ	-6-dB-bandwidth > ±8.0 kHz
BANDWIDTH / 8.33 KHZ	-6-dB-bandwidth > ±2.78 kHz
SELECTIVITY (channel spacing 25 KHZ)	-40-dB-bandwidth < ±17.0 kHz -60-dB-bandwidth < ±22.0 kHz
SELECTIVITY (channel spacing 8.33 KHZ)	-60-dB-bandwidth < ±7.37 kHz
SPEAKER OUTPUT	≥10 W into 4 Ω
AGC CHARACTERISTIC	Deviation of NF-output < 6 dB from 10 μV to 10 mV
SQUELCH	Automatic Squelch (adjustable)
SPURIOUS RESPONSES	> 80 dB

	User & Installation manual VHF- Communication Transceiver	Doc.-Nr: DE-3000-800100e
	KRT2 & KRT 2A	Revision 9.6 For Software >5.00 Sept.2013

DISTORTION (350...2500Hz)	<25% at rated power (85% / -33dBm) <10% at 10dB below rated power (70% / -33dBm)
----------------------------------	--

	User & Installation manual VHF- Communication Transceiver	Doc.-Nr: DE-3000-800100e
	KRT2 & KRT 2A	Revision 9.6 For Software >5.00 Sept.2013